

# 14CXN76

**8Ω****Coaxials - 13.5 Inches**

- 800 W continuous program power capacity
- 80° nominal coverage
- 45 - 18000 Hz response
- 100 dB sensitivity
- Single Neodymium magnet assembly
- Aluminium demodulating ring for very low distortion

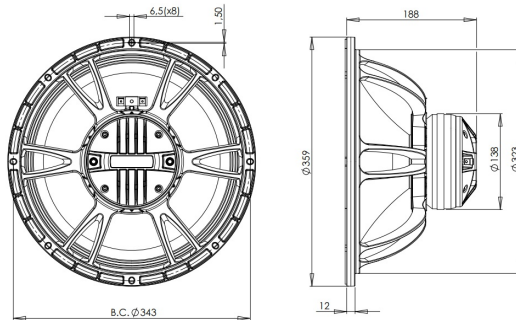

# 14CXN76

Coaxials- 13.5 Inches

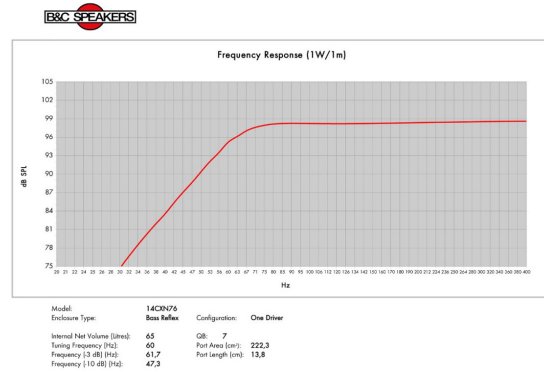
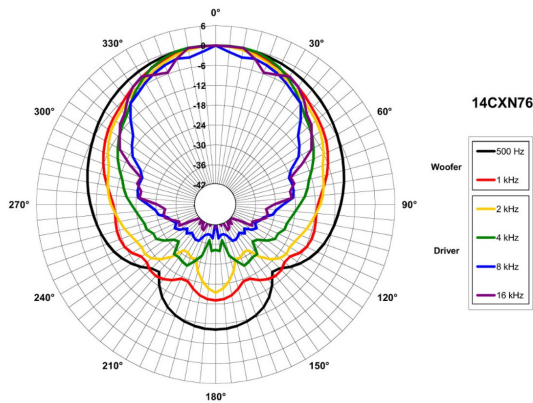
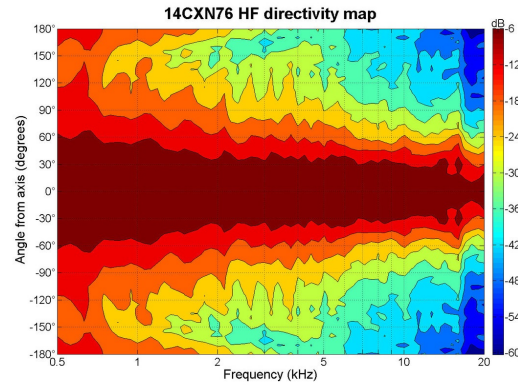
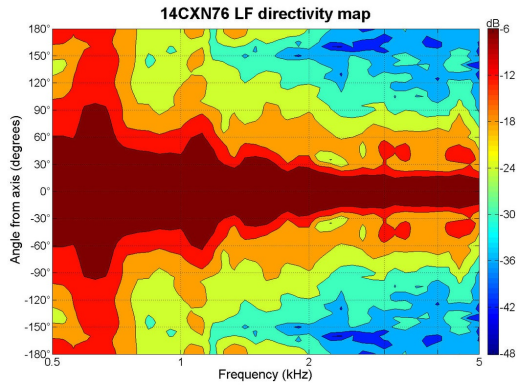
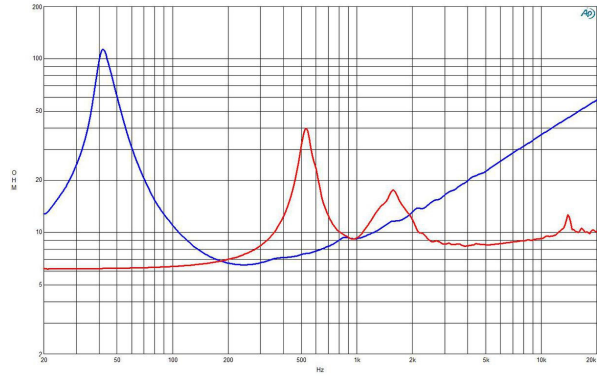
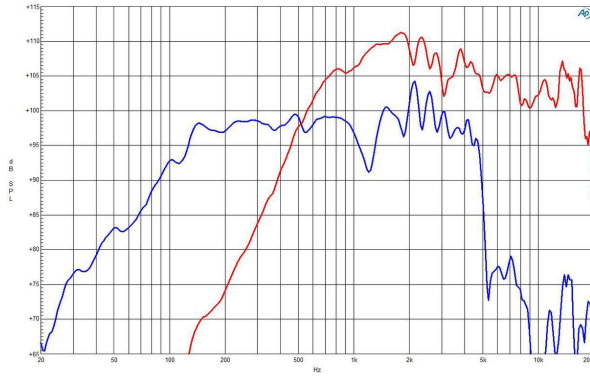

## SPECIFICATIONS

Nominal Diameter	343 mm (13.5 in)
Nominal Impedance	8 Ω
Minimum Impedance LF	6.5 Ω
Minimum Impedance HF	8.2 Ω
Frequency Range	45 - 18000 Hz
Dispersion Angle <sup>1</sup>	80 °
Woofer Cone Treatment	WP Waterproof Front Side
Magnet Material	Neodymium Ring

## SPECIFICATIONS LF UNIT

Sensitivity <sup>2</sup>	100.0 dB
Nominal Power Handling <sup>3</sup>	400 W
Continuous Power Handling <sup>4</sup>	800 W
Voice Coil Diameter	76 mm (3.0 in)
Winding Material	Copper
Flux Density	1.05 T
Former Material	Glass Fibre
Winding Depth	16.5 mm (0.65 in)
Magnetic Gap Depth	9.0 mm (0.35 in)

## SPECIFICATIONS HF UNIT

Sensitivity <sup>5</sup>	105.0 dB
Nominal Power Handling <sup>6</sup>	80 W
Continuous Power Handling <sup>7</sup>	160 W
Voice Coil Diameter	75 mm (3.0 in)
Winding Material	Aluminium
Flux Density	1.8 T
Diaphragm Material	Polyester/Titanium
Recommended Crossover <sup>8</sup>	1.2 kHz
Inductance	0.14 mH

B&C Speakers s.p.a.

Via Poggiomoro, 1 - Loc. Vallina, 50012 Bagno a Ripoli (FI) - ITALY - Tel. +39 055 65721 - Fax +39 055 6572312 - mail@bcspeakers.com

**PARAMETERS**

Resonance Frequency	45 Hz
Re	5.2 $\Omega$
Qes	0.29
Qms	8.5
Qts	0.28
Vas	131.0 dm <sup>3</sup> (4.63 ft <sup>3</sup> )
Sd	707.0 cm <sup>2</sup> (109.59 in <sup>2</sup> )
$\eta_e$	4.0 %
Xmax	$\pm$ 6.0 mm
Xvar	$\pm$ 8.0 mm
Mms	67.0 g
Bl	18.4 Txm
Le	1.0 mH
EBP	155 Hz

**MOUNTING AND SHIPPING INFO**

Overall Diameter	359 mm (14.13 in)
Bolt Circle Diameter	343 mm (13.5 in)
Baffle Cutout Diameter	323 mm (12.72 in)
Depth	188 mm (7.4 in)
Flange and Gasket Thickness	12 mm (0.47 in)
Net Weight	5.6 kg (12.35 lb)
Shipping Units	1
Shipping Weight	6.9 kg (15.21 lb)
Shipping Box	425x425x224 mm (16.73x16.73x8.82 in)

**CROSSOVER****SERVICE KIT**

LF recone kit	RCK14CXN768
MF replacement diaphragm	MMD9028M

1. Included by -6 dB down points.
2. Applied RMS Voltage is set to 2.83V.
3. 2 hours test made with continuous pink noise signal within the range Fs-10Fs. Power calculated on rated minimum impedance. Loudspeaker in free air.
4. Power on Continuous Program is defined as 3 dB greater than the Nominal rating.
5. Applied RMS Voltage is set to 2.83V.
6. 2 hour test made with continuous pink noise signal within the range from the recommended crossover frequency to 20 kHz. Power calculated on rated minimum impedance. Loudspeaker in free air.
7. Power on Continuous Program is defined as 3 dB greater than the Nominal rating.
8. 12 dB/oct. or higher slope high-pass filter.